

V131 / V145 / V147 / V157 / V158

NSYV1CCD1-A2010

SEIKO WATCH CORPORATION

Copyright©2020 by SEIKO WATCH CORPORATION

Printed in Japan

D-14

SEIKO

V131 / V145 / V147 / V157 / V158

DIVER'S WATCH FOR AIR DIVING INSTRUCTIONS

日本語 **JA 1**

English **EN 1**

そのほかの言語の取扱説明書は、パソコンやスマートフォンから当社ホームページ内の「カスタマーサービス」>「取扱説明書ダウンロード」にアクセスいただき、ご覧ください。

Please refer to the Instruction Manuals of other languages by accessing "Customer Service"→ "Instruction" on our Website from PC or Smartphone.

Deutsch / Français / Italiano / Español /
Русский язык / العربية / Português /
简体中文 / 繁體中文 / 한국어 / ไทย



<https://www.seikowatches.com/>

**Thank you very much for choosing a SEIKO watch.
For proper and safe use of your SEIKO watch,
please read carefully the instructions in this
booklet before using it.**

Keep this manual handy for easy reference.

- * Length adjustment service for metallic bands is available at the retailer from whom the watch was purchased. If you cannot have your watch repaired by the retailer from whom the watch was purchased because you received the watch as a gift, or you moved to a distant place, please contact SEIKO CUSTOMER SERVICE CENTER. The service may also be available on a chargeable basis at other retailers, however, some retailers may not undertake the service.
- * If your watch has a protective film for preventing scratches, make sure to peel it off before using the watch. If the watch is used with the film on it, dirt, sweat, dust, or moisture may be attached to the film and may cause rust.

EN 1

⚠ WARNING

Make sure to read the following instructions before use and strictly observe them.

⚠ WARNING

When diving, never carry out operations other than those specified in this instruction manual. Mishandling of the product and misunderstanding of the displayed content may lead to a fatal or serious accident.

⚠ WARNING

The diver's watch is an auxiliary instrument which mainly displays the passage of time and does not ensure the safety of a user. Use this watch while using the equipment (residual pressure gauge, water depth meter, etc.) required for safe diving.

⚠ WARNING

Never use this watch for "saturation diving" using helium gas.

⚠ WARNING

Do not dive using this product unless you have been properly trained in scuba diving, acquired the requisite experience and techniques for safe diving, thoroughly familiarized yourself with the operation and handling of this product, and inspect all functions of this product prior to each dive.

⚠ CAUTION

Make sure to read the following instructions before use and strictly observe them.

⚠ CAUTION

Inspect the following items before diving (excluding saturation diving):

- The watch is normally operating.
- The remaining battery level is sufficient and the mainspring is sufficiently wound.
- The rotating bezel turns smoothly. (The bezel rotation must not be too loose or too tight.)
- Screws of the crown and other parts are reliably tightened.
- No abnormalities such as flaws or cracks exist on the band or glass.
- The band is reliably fixed (with spring bar, buckle or other parts.)

* If any abnormality is observed in the above items, do not use this watch for diving.

⚠ CAUTION

Do not operate the crown or buttons underwater.

⚠ CAUTION

As the use environment of the diver's watch may affect not only the case or band but also the internal mechanism of the watch, we recommend that you periodically request an overhaul for inspection and adjustment approximately once every three to four years.

EN 2

EN 3

CONTENTS

1 HOW TO USE

Handling cautions	6
Precautions for diving (Please make sure to observe the following.)	10
Before diving	10
While diving	12
After diving	13
Structure of the case	14
Characteristics	15
Names of the parts and their functions	16
Screw down crown	17
How to use the rotating bezel	18

2 HOW TO SET THE TIME AND DATE

How to set the time and date	20
How to set the time and date	20
Manual date adjustment at the end of the month	23

3 SOLAR CHARGING FUNCTION

Charging the battery	24
How to charge the battery	24
Guide to charging times	25
About energy	27

4 TO PRESERVE THE QUALITY OF YOUR WATCH

Daily care	28
Performance and type	29
Lumibrite	30
Power Source	31
Magnetic resistant performance	33
Band	35
How to use the diver adjuster	37
How to use the diver extender	39
After sales service	41

5 TROUBLESHOOTING

Troubleshooting	43
-----------------------	----

6 SPECIFICATIONS

Specifications	45
----------------------	----

Handling cautions

WARNING

Please note that there is a risk of serious consequences such as severe injury if the following safety regulations are not strictly observed.

Immediately stop wearing the watch in following cases:

- If the watch body or band becomes edged by corrosion etc.
- If the pins protrude from the band.
- * Immediately consult the retailer from whom the watch was purchased or SEIKO CUSTOMER SERVICE CENTER.

Keep the watch and accessories out of the reach of babies and children.

Care should be taken to prevent a baby or a child accidentally swallowing the accessories. If a baby or child swallows the battery or accessories, immediately consult a doctor, as it will be harmful to the health of the baby or child.

Do not remove the secondary battery from the watch.

* About the secondary battery → Power Source → P. 31
Replacement of the secondary battery requires professional knowledge and skill. Please ask the retailer from whom the watch was purchased for replacement of the secondary battery.
Installation of an ordinary silver oxide battery can generate heat that can cause bursting and ignition.

CAUTION

Please note that there is a risk of minor injury or material damage if the following safety regulations are not strictly observed.

Avoid the following places for wearing or keeping the watch:

- Places where volatile agents (cosmetics such as polish remover, bug repellent, thinners etc.) are vaporizing
- Places where the temperature drops below 5°C or rises above 35°C for a long time
- Places affected by strong magnetism or static electricity
- Places affected by strong vibrations
- Places of high humidity
- Dusty places

If you observe any allergic symptoms or skin irritation

Stop wearing the watch immediately and consult a specialist such as a dermatologist or an allergist.

Other cautions

- For adjusting the length of the metallic band, specialized knowledge and expertise are necessary. Therefore, in such a case, contact the retailer from whom the watch was purchased. If you attempt to adjust the metallic band, injury may occur to your hand or fingers, or parts of the band may be lost.
- Do not disassemble or tamper with the watch.
- Keep the watch out of the reach of babies and children. Extra care should be taken to avoid risks of any injury or allergic rash or itching that may be caused when they touch the watch.
- If your watch is of the fob or pendant type, the strap or chain attached to the watch may damage your clothes, or injure the hand, neck, or other parts of your body.

⚠ WARNING

Never use the watch, in saturation diving using helium gas.

⚠ WARNING

While diving, never operate the watch in any other manner than set forth in the instruction manual.

⚠ WARNING

Before using the diver's watch, you have to be properly trained in various types of diving and possess the requisite experience and skill to dive safely. When diving, strictly abide by the rules of diving.

1 Precautions for diving (Please make sure to observe the following.)

■ Before diving

Before diving, check the following:

* "Names of the parts and their functions" → P. 16

- 1** The time is correctly set.
- 2** The seconds hand is moving at one-second intervals.
If the hand is moving at two-second intervals or it is stopped, place the dial under light to charge the battery.
* "Charging the battery" → P. 24
- 3** The rotating bezel turns smoothly.
(The bezel rotation must not be too loose or too tight.)
* "How to use the rotating bezel" → P. 18

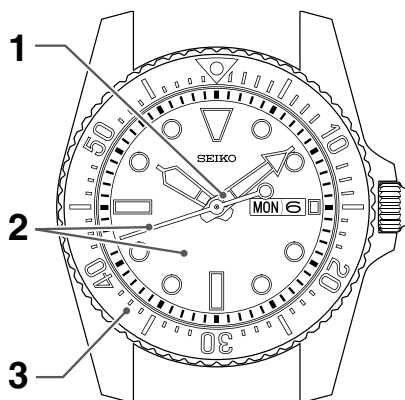

⚠ CAUTION

Please note that there is a risk of minor injury or material damage if the following safety regulations are not strictly observed.



Do not turn or pull out the crown when the watch is wet.

Water may get inside of the watch.

* If the inner surface of the glass is clouded with condensation or water droplets appear inside of the watch for a long time, the water resistant performance of the watch is deteriorated. Immediately consult the retailer from whom the watch was purchased or SEIKO CUSTOMER SERVICE CENTER.



Do not leave moisture, sweat and dirt on the watch for a long time.

Be aware of a risk that a water resistant watch may lessen its water resistant performance because of deterioration of the adhesive on the glass or gasket, or the development of rust on stainless steel.



Do not wear the watch while taking a bath or a sauna.

Steam, soap or some components of a hot spring may accelerate the deterioration of water resistant performance of the watch.

- 4** The crown is completely screwed in.

* "Screw down crown" → P. 17

- 5** There are no visible cracks or scratches on the crystal or watch band.

- 6** The band is firmly attached to the watch (with spring bars, clamp or other parts.)

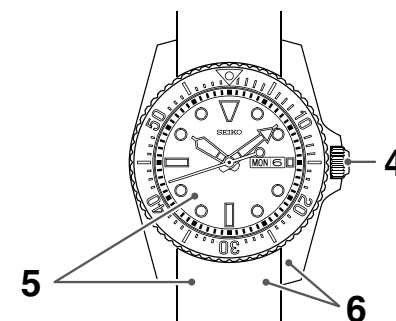

⚠ CAUTION

If there are any malfunctions, contact the retailer from whom the watch was purchased or SEIKO CUSTOMER SERVICE CENTER.

■ While diving

Please observe the following cautions for use.



The watch can be used for air diving within the water resistant range displayed on the dial.

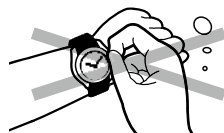

Do not operate the crown or buttons underwater.



Take care not to bump the watch against hard objects such as rocks.



Bezel rotation may become slightly harder in the water but this is not a malfunction.

■ Structure of the case

In the following types of models, take care of the following issues in usage.

The bezel or protective outer case is securely fastened to the watch with setscrews.
Never loosen the setscrews.

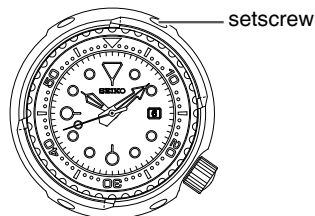
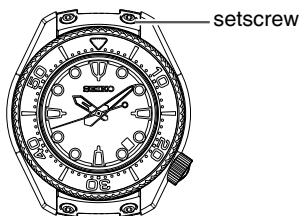

* The above illustration is provided as an example, therefore it may not be exactly the same as your watch.

⚠ CAUTION

Never loosen the setscrews used to fix the bezel or protective outer case. Doing so may cause damage or result in further loosening.

* If you find that the setscrews have become loose or are functioning abnormally, consult the retailer from whom the watch was purchased or SEIKO CUSTOMER SERVICE CENTER.

■ After diving

Please follow the care instructions below after diving.

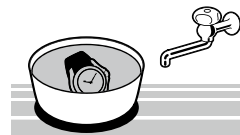

Rinse the watch in fresh water to wash out all seawater and wipe it thoroughly dry to prevent rust. Avoid pouring running water onto the watch directly from a faucet. Put some water into a bowl first, and then soak the watch in the water to wash it.

⚠ CAUTION

Depending on the environment where a diver's watch is used, its inner parts or movement as well as its case or band may be affected. We recommend that you have your watch overhauled regularly once every 3 or 4 years.

Characteristics

■ Water resistant performance for air diving...

This watch is equipped with water resistant performance to be used in water for a long period of time with scuba diving tanks. (It cannot be used for saturation diving that uses helium gas.)

■ Solar charging function.....

The watch operates while charging electricity by converting light received on a solar cell placed beneath the dial to electrical energy. It cannot properly operate unless the remaining energy is sufficient. Place or store the watch in a location receiving light etc., to sufficiently charge electricity.

"How to charge the battery" → P. 24

"Guide to charging times" → P. 25

"Power Source" → P. 31

Names of the parts and their functions

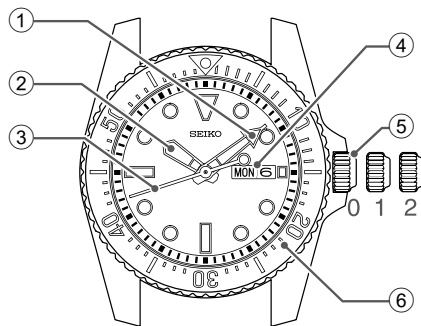

- ① Minute hand
- ② Hour hand
- ③ Seconds hand
- ④ Date/Day of the Week
"Date (Day of the week) setting" → P. 21
- ⑤ Crown
- ⑥ Rotating bezel
"How to use the rotating bezel" → P. 18

* Some models may not have date/day of the week.

Screw down crown

The screw down crown features a mechanism that can securely lock the crown when it is not being operated in order to prevent any operational errors and to improve its water resistant performance.

- **It is necessary to unlock the screw down crown before operating it.**
- **Once you have finished operating the crown, make sure to relock it.**

[To unlock the crown]

Turn the crown counterclockwise to unscrew it.
Now the crown can be operated.

[To lock the crown]

Turn the crown clockwise while gently pressing it in toward the watch body until it stops.

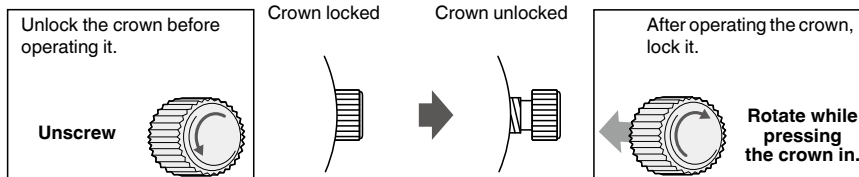

* When locking the crown, turn it slowly with care, ensuring that the screw is properly engaged. Be careful not to push it in forcefully, as doing so may damage the screw hole in the case.

How to use the rotating bezel

By setting the rotating bezel beforehand, the elapsed time since the start of an event can be measured.

- 1 At the start of the event, for which you want to measure the elapsed time (for example, when you start diving), rotate the bezel so that the ▼ mark on the bezel is aligned with the minute hand.**

* The rotating bezel is designed to rotate only counterclockwise.
Do not forcibly rotate it clockwise.
["One-Way rotating bezel"] → P. 19

Example: When you start diving at 10:10 am.

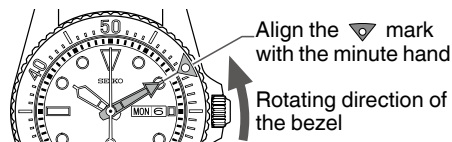

- 2 Read the graduation on the rotating bezel to which the minute hand is pointing.**

The graduation on the rotating bezel to which the minute hand is pointing indicates the elapsed time.

Example: After 20 minutes has elapsed

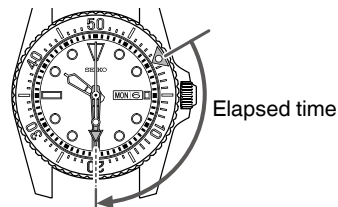

* The above illustration is provided as an example, therefore it may not be exactly the same as your watch.

[One-Way rotating bezel]

As the evaluation of the remaining air in your cylinder is based on the information of the elapsed time of the dive, the rotating bezel for a diver's watch is designed to rotate only counterclockwise, so that the watch is prevented from displaying the elapsed time shorter than it actually is.

⚠ CAUTION

Make sure that you check the correct remaining amount of air in your cylinder before diving.
Use the display of the elapsed time by the rotating bezel only as a guide during diving.

How to set the time and date

2

HOW TO SET THE TIME AND DATE

How to set the time and date

To set date independently, refer to "Date (Day of the week) setting" → P. 21.
* Some models may not have date/day of the week.

Time setting

1 Pull out the crown to the second click.

Pull out the crown to the second click when the seconds hand is at the 12 o'clock position; the seconds hand stops on the spot.

- For models with screw down crown, please unlock the crown before operating it.

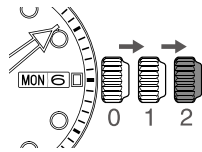

2 Turn the crown to set the time.

In order to set the time accurately, turn the minute hand 4 to 5 minutes ahead and then return it to the correct time.

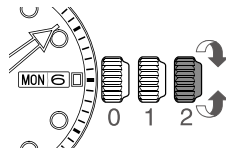

EN 20

2

HOW TO SET THE TIME AND DATE

1 Pull out the crown to the first click.

- For models with screw down crown, please unlock the crown before operating it.

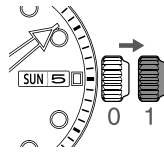

2 Turn the crown to set the date (day of the week).

Day of the week can be displayed either in Japanese or English by your choice.

- Some models display the date and day of the week in the reverse order.

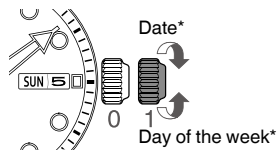

3 Push the crown back in to the normal position.

- For models with screw down crown, please be sure to lock the crown after operating it.

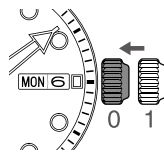

EN 22

3 Push the crown back in to the normal position in accordance with a time signal.

- The telephone time signal service is helpful for setting the seconds hand exactly.
- For models with screw down crown, please be sure to lock the crown after operating it.

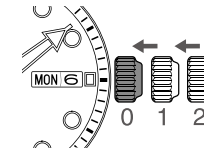

2

HOW TO SET THE TIME AND DATE

Date (Day of the week) setting

Date/day of week-displaying models are so designed that the date changes once every 24 hours. The date (day of the week) changes around 12 o'clock midnight. If AM/PM is not properly set, the date will change at 12 o'clock noon.

CAUTION

Do not set the date (day of week) within the following time frames. Amending the date during this time period may cause problems such as the date failing to change the next day or may cause damage.

Date-displaying models: 9:00 pm to 1:00 am

Date/day of week-displaying models: 9:00 pm to 4:00 am

EN 21

Manual date adjustment at the end of the month

It is necessary to adjust the date at the end of February and 30-day months.

- Some models may not have date/day of the week.

Ex.) To adjust the date in the A.M. period on the first day of a month following a 30-day month

The watch displays "31" instead of "1." Pull out the crown to the first click.

Turn the crown to set the date to "1" and then push the crown back in to the normal position.

- Some models display the date and day of the week in the reverse order.

- For models with screw down crown, please be sure to lock the crown after operating it.

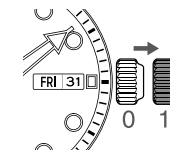

2

HOW TO SET THE TIME AND DATE

CAUTION

Avoid amending the date within the following time frames. Doing so may cause damage.

Date-displaying models: 9:00 pm to 1:00 am

Date/day of week-displaying models: 9:00 pm to 4:00 am

EN 23

Charging the battery

How to charge the battery

Expose the dial to light to charge the watch.

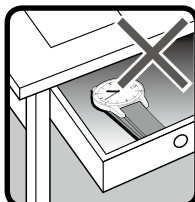
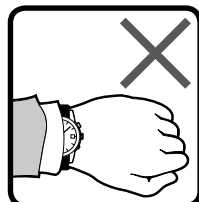

To ensure optimal performance of the watch, make sure that the watch is kept sufficiently charged at all times.

Under the following situations, the energy of the watch is likely to be depleted, resulting in stoppage of the watch:

- The watch is concealed under a sleeve.
- The watch is used or stored under conditions where it cannot be exposed to light for a long time.

* Be careful to make sure that the watch does not get hot when it is charging. (The operating temperature range is -10°C to +60°C.)

* When you first start using the watch or starting it after it stopped due to a lack of charge, charge the watch sufficiently using the table on P. 25 as a guide.

EN 24

3 SOLAR CHARGING FUNCTION

Guide to charging times

Charge the watch using the times below as a guide.

The figures of "Time required for charging the watch to start moving at one-second intervals" are estimations of time required to charge the stopped watch by exposing it to light until it moves at steady one-second intervals. Even if the watch is partially charged for a shorter period, the watch will resume one-second-interval movement. However, it may shortly return to two-second-interval movement. Use the charging time in this column as a rough guide for sufficient charging time.

* The required charging time slightly varies depending on the model of the watch.

● V131

Illuminance lx (LUX)	Light source	Condition (Example)	Time required for fully charging the watch	Time required to get the small seconds hand moving at one-second intervals	Time required for charging the watch to last for 1 day
700	Fluorescent light	General offices	-	16 hours	1.8 hours
3,000	Fluorescent light	30W 20cm	90 hours	4 hours	30 minutes
10,000	Sunlight	Cloudy day	30 hours	1.2 hours	8 minutes
100,000	Sunlight	Sunny day (Under the direct sunlight on a summer day)	10 hours	6 minutes	1 minute

EN 25

3 SOLAR CHARGING FUNCTION

● V145

Illuminance lx (LUX)	Light source	Condition (Example)	Time required for fully charging the watch	Time required to get the small seconds hand moving at one-second intervals	Time required for charging the watch to last for 1 day
700	Fluorescent light	General offices	175 hours	11 hours	50 minutes
3,000	Fluorescent light	30W 20cm	40 hours	2 hours	10 minutes
10,000	Sunlight	Cloudy day	10 hours	30 minutes	3 minutes
100,000	Sunlight	Sunny day (Under the direct sunlight on a summer day)	3 hours	6 minutes	1 minute

● V147 / V157 / V158

Illuminance lx (LUX)	Light source	Condition (Example)	Time required for fully charging the watch	Time required to get the small seconds hand moving at one-second intervals	Time required for charging the watch to last for 1 day
700	Fluorescent light	General offices	-	25 hours	1.8 hours
3,000	Fluorescent light	30W 20cm	120 hours	6 hours	30 minutes
10,000	Sunlight	Cloudy day	35 hours	2 hours	10 minutes
100,000	Sunlight	Sunny day (Under the direct sunlight on a summer day)	9 hours	24 minutes	2 minutes

EN 26

3 SOLAR CHARGING FUNCTION

About energy

When the energy stored in the watch is running down, the seconds hand starts moving at two-second intervals.

If the energy runs out, the watch will stop.

If the seconds hand starts moving at two-second intervals, fully charge the watch.

How to charge the battery → P. 24

Guide to charging times → P. 25

EN 27

3 SOLAR CHARGING FUNCTION

Daily care

● The watch requires good daily care

- Do not wash the watch when its crown is in the extended position.
- Wipe away moisture, sweat or dirt with a soft cloth.
- After soaking the watch in seawater, be sure to wash the watch in clean pure water and wipe it dry carefully.
Do not pour running water directly from a faucet onto the watch. Put some water into a bowl first, and then soak the watch in the water to wash it.
* If your watch is rated as "Non-water resistant" or "water resistant for everyday life", do not wash the watch.
"Performance and type" → P. 29

● Turn the crown from time to time

- In order to prevent corrosion of the crown, turn the crown from time to time.
- The same practice should be applied to a screw down crown.
"Screw down crown" → P. 17

Performance and type

The case back shows the caliber and performance of your watch

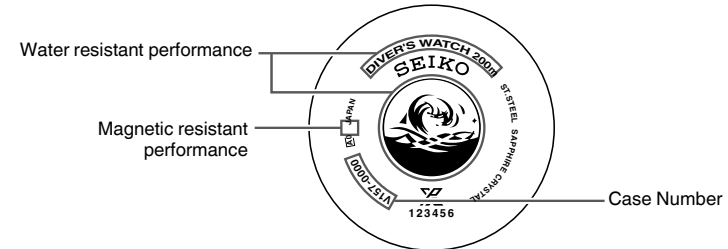

- Water resistant performance**
- Case Number**
The number to identify the type of your watch.
- Magnetic resistant performance**
Refer to pages P. 33 and P. 34.

* The above illustration is provided as an example, therefore it may not be exactly the same as your watch.

Lumibrite

If your watch has Lumibrite

Lumibrite is a luminous paint that absorbs the light energy of sunlight and lighting apparatuses in a short time and stores it to emit light in the dark. For example, if exposed to a light of more than 500 lux for approximately 10 minutes, Lumibrite can emit light for 3 to 5 hours. Please note, however, that, as Lumibrite emits the light it stores, the luminance level of the light decreases gradually over time. The duration of the emitted light may also differ slightly depending on such factors as the brightness of the place where the watch is exposed to light and the distance from the light source to the watch.

* In general, when coming from a place that is bright to a place that is dark, it takes human eyes some time to adapt to the darkness making it difficult to see objects initially. (Dark adaptation)

* Lumibrite is luminous paint that stores and emits light, which is harmless to human beings and the environment, containing no toxic materials such as radioactive substances.

<Brightness levels>

Condition		Illumination
Sunlight	Fine weather	100,000 lux
	Cloudy weather	10,000 lux
Indoor (Window-side during daytime)	Fine weather	more than 3,000 lux
	Cloudy weather	1,000 to 3,000 lux
	Rainy weather	less than 1,000 lux
Lighting apparatus (40-watt daylight fluorescent light)	Distance to the watch: 1 m	1,000 lux
	Distance to the watch: 3 m	500 lux (average room luminance)
	Distance to the watch: 4 m	250 lux

Power Source

The battery used in this watch is a special secondary battery, which is different from ordinary batteries.

Unlike an ordinary silver oxide battery, the secondary battery does not require periodic replacement.

The capacity or charging efficiency may gradually lower due to long-term use or operating environment.

In addition, long-term use may shorten the charge duration due to wear, contamination, lubricant deterioration of mechanical parts, etc. Request repair when the performance lowers.

⚠ WARNING

■ Notes on replacing the secondary battery

- Do not remove the secondary battery from the watch.
Replacement of the secondary battery requires professional knowledge and skill. Please ask the retailer from whom the watch was purchased for replacement of the secondary battery.
- Installation of an ordinary silver oxide battery can generate heat that can cause bursting and ignition.

* Overcharge prevention function

When the secondary battery is fully charged, the overcharge prevention function is automatically activated to avoid further charging.

There is no need to worry about damage caused by overcharging no matter how much the secondary battery is charged in excess of the "time required for fully charging the watch."

* For the required time to fully charge the battery, see "Guide to charging times" → P. 25.

⚠ WARNING

■ Notes on charging the watch

- When charging the watch, do not place the watch in close proximity to an intense light source such as lighting equipment for photography, spotlights or incandescent lights, as the watch may be excessively heated resulting in damage to its internal parts.
- When charging the watch by exposure to direct sunlight, avoid places that easily reach high temperatures, such as a car dashboard.
- Always keep the watch temperature under 60°C.

Examples of common magnetic products that may affect watches



Smartphone, cellular phone, tablet terminal
(speaker, magnet of cover)

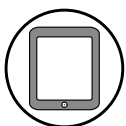

AC adapter



Bag
(with magnet buckle)



AC-powered
shaver



Magnetic
cooking device

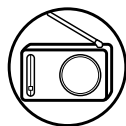

Portable radio
(speaker)

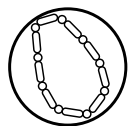

Magnetic
necklace

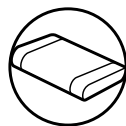

Magnetic health
pillow

Magnetic resistant performance

Affected by nearby magnetism,
a watch may temporarily gain or lose time or stop operating.

Diver's watches feature magnetic resistant performance which is equivalent to or above JIS Class 1.

⚠ DANGER	
Indication on the case back	Condition of use
No indication	Keep the watch more than 5 cm away from magnetic products. (JIS level-1 standard)
	Keep the watch more than 1 cm away from magnetic products. (JIS level-2 standard)

If the watch becomes magnetized and its accuracy deteriorates to an extent exceeding the specified rate under normal use, the watch needs to be demagnetized. In this case, you will be charged for demagnetization and accuracy readjustment even if it happens within the guarantee period.

The reason why a watch is affected by magnetism

The built-in motor is provided with a magnet, which may be influenced by a strong external magnetic field.

Band

The band touches the skin directly and becomes dirty with sweat or dust. Therefore, lack of care may accelerate deterioration of the band or cause skin irritation or stain on the sleeve edge. The watch requires a lot of attention for long usage.

● Metallic band

- Moisture, sweat or soil will cause rust even on a stainless steel band if they are left for a long time.
- Lack of care may result in a rash or cause a yellowish or gold stain on the lower sleeve edge of shirts.
- Wipe off moisture, sweat or soil with a soft cloth as soon as possible.
- To clean the soil around the joint gaps of the band, wipe it out in water and then brush it off with a soft toothbrush.
(Protect the watch body from water splashes by wrapping it up in plastic wrap etc.)
Clean it off with a soft cloth.
- Because some titan bands use pins made of stainless steel, which has outstanding strength, rust may form in the stainless steel parts.
- If rust advances, pins may poke out or drop out, and the watch case may fall off the band, or the clasp may not open.
- If a pin is poking out, personal injury may result. In such a case, refrain from using the watch and request repair.

● Polyurethane band

- A polyurethane band is susceptible to discoloration from light, and may be deteriorated by solvent or atmospheric humidity.
- Especially a translucent, white, or pale colored band easily adsorbs other colors, resulting in color smears or discoloration.
- Wash out dirt in water and clean it off with a dry cloth. (Protect the watch body from water splashes by wrapping it up in plastic wrap etc.)
- When the band becomes less flexible, have the band replaced with a new one. If you continue to use the band as it is, the band may develop cracks or become brittle over time.

● Silicone band

- As for material characteristics, the band is easily dirtied, and may be stained and discolored. Wipe off dirt with a wet cloth or cleaning tissue.
- Unlike bands of other materials, cracks may result in the band being cut. Take care not to damage the band with an edged tool.

Notes on skin irritation and allergy	Skin irritation caused by a band may result from various factors such as allergy to metals or leathers, or skin reactions against friction on dust or the band itself.
Notes on the length of the band	Adjust the band to allow a little clearance with your wrist to ensure proper airflow. When wearing the watch, leave enough room to insert a finger between the band and your wrist. 

- 3** While pressing the push button, lift up the clasp to release the buckle, and place the watch on your wrist.

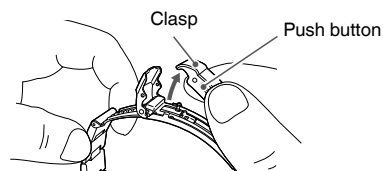

- 4** Close the clasp (4-1) first and then, the flap (4-2).

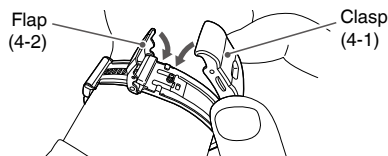

- 5** Hold both sides of the band to adjust the length of the slider until it fits snugly around your wrist.

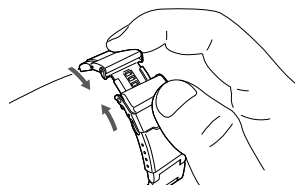

How to use the diver adjuster

If your watch's metallic band has the Diver Adjuster function, the length of the band can be easily adjusted.

It is very useful when you wear the watch over a wet suit or winter clothing.

- 1** Lift up the flap approximately 90° until it stands upright, and then press the flap down further approximately 20° and lightly hold it.

- When doing so, take care not to push the flap forcibly. Although you may feel slight resistance, doing this requires only a light force.

- 2** Lightly pull the band on the 6 o'clock side of the watch along the curved line of the band to pull out the slider.

- Doing this requires only a light force. Take care not to pull the band forcibly.
- The slider can be pulled out approximately 30 mm. Take care not to pull it out more than this limit.

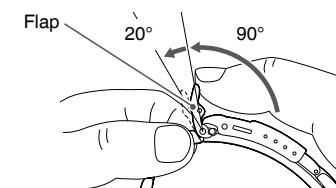

Band on the 6 o'clock side of the watch

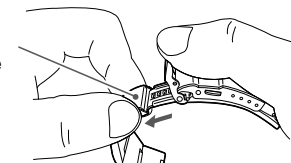

How to use the diver extender

If your watch's metallic band has the Diver Extender function, the length of the band can be easily adjusted.

It is very useful when you wear the watch over a wet suit or winter clothing.

- 1** Lift up the flap.

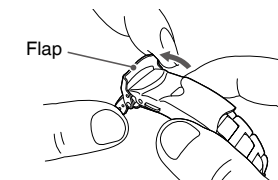

- 2** While pressing the push button, open the clasp.

- After opening the clasp, push the flap back to the normal position for safety's sake.

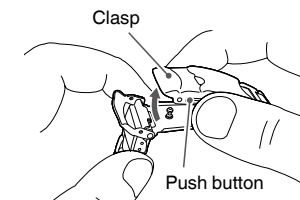

3 Open the two-piece foldover portion of the Diver Extender in the direction of the arrow.

- Some force is required to open the foldover portion, and it will click when it is opened.

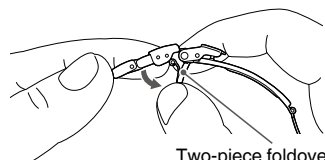

Two-piece foldover portion of the Diver Extender

4 Slide the upper cover of the Diver Extender in the direction of the arrow, and then, pull it up to extend the two-piece foldover portion to the full extent.

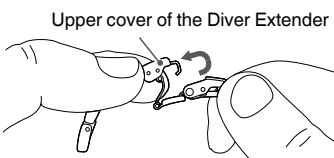

Upper cover of the Diver Extender

5 Place the watch on your wrist, and close the clasp (5-1) first and then, the flap (5-2).

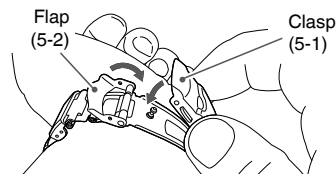

Flap (5-2) Clasp (5-1)

- To fold up the Diver Extender, reverse the procedure above. When the two-piece folder portion of the Diver Extender is folded up completely, it also clicks in the same manner as when it is opened.

EN 40

● Inspection and adjustment by disassembly and cleaning (overhaul)

- Periodic inspection and adjustment by disassembly and cleaning (overhaul) is recommended approximately once every 3 to 4 years in order to maintain optimal performance of the watch for a long time. According to use conditions, the oil retaining condition of your watch mechanical parts may deteriorate, abrasion of the parts may occur due to contamination of oil, which may ultimately lead the watch itself to stop. As the parts such as gasket may deteriorate, water-resistant performance may be impaired due to intrusion of perspiration and moisture. Please contact the retailer from whom the watch was purchased for inspection and adjustment by disassembly and cleaning (overhaul). For replacement of parts, please specify "SEIKO GENUINE PARTS." When asking for inspection and adjustment by disassembly and cleaning (overhaul), make sure that the gasket and push pin are also replaced with new ones.
- When your watch is inspected and adjusted by disassembly and cleaning (overhauled), the movement of your watch may be replaced.

⚠ CAUTION

Depending on the environment where a diver's watch is used, its inner parts or movement as well as its case or band may be affected. We recommend that you have your watch overhauled regularly once every 3 or 4 years.

EN 42

After sales service

● Notes on guarantee and repair

- Contact the retailer from whom the watch was purchased or SEIKO CUSTOMER SERVICE CENTER for repair or overhaul.
- Within the guarantee period, present the certificate of guarantee to receive repair services.
- Guarantee coverage is provided in the certificate of guarantee. Read carefully and retain it.
- For repair services after the guarantee period has expired, if the functions of the watch can be restored by repair work, we will undertake repair services upon request and payment.

● Replacement with functional parts

- Please keep in mind that if original parts are not available, they may be replaced with substitutes whose outward appearance may differ from the originals.

EN 41

Troubleshooting

Troubles	Possible causes	Solutions	Reference
The watch stops operating.	The power is completely depleted or low.	Sufficiently charge the battery until the seconds hand moves every second.	P. 24
The seconds hand is moving at two-second intervals.	If you wear the watch every day and this occurs, the most likely cause is the watch is hidden by your sleeves or other clothing when you wear it and it is not sufficiently exposed to light.	When you wear the watch, try to make sure that the watch is not hidden by your sleeves or other clothing. Additionally, when you take the watch off, try to place it in a bright place.	
The stopped watch was exposed to an adequate light for longer than "the time required to fully charge the watch," however, it does not resume its normal one-second interval movements or even does not start operating.	The light is too weak. More time is required to fully charge the watch.	The time taken to charge will differ depending on the light intensity. For details on charging times, see "Guide to charging times" → (P. 25).	P. 25

EN 43

Troubles	Possible causes	Solutions	Reference
The watch temporarily gains/loses time.	The watch has been left in extremely high or low temperatures for a long time.	If the watch returns to room temperature, the accuracy will return to its original state. If it does not return to its original state, contact the retailer from whom the watch was purchased.	-
	The watch has been left close to an object with a strong magnetic field.	Correct this condition by moving and keeping the watch away from the magnetic source, and reset the time. If this action does not correct the condition, contact the retailer from whom the watch was purchased.	-
	You drop the watch, hit it against a hard surface, or wear it while playing active sports. The watch is exposed to strong vibrations.	If accuracy does not return after setting the time, consult the retailer from whom the watch was purchased.	-
The date changes at 12 o'clock noon.	AM/PM is not properly set.	Advance the hands by 12 hours.	P. 20
Blur in the display persists.	Small amount of water has got inside the watch due to deterioration of the gasket, etc.	Consult the retailer from whom the watch was purchased.	-

* Contact the retailer from whom the watch was purchased for any other troubles.

Specifications

Cal.	V131 / V145 / V147 / V157 / V158
1. Features	3 hands (hours, minutes, seconds), date display (excluding V131)
2. Frequency of crystal oscillator	32,768 Hz (Hz= Hertz, cycles per second)
3. Loss/gain (monthly rate)	Monthly average loss/gain \pm 15 seconds Only if worn on the wrist in a temperature range of 5°C to 35°C
4. Operational temperature range	-10 °C ~ +60 °C
5. Driving system	Three step motors
6. Power source	Secondary battery, 1 piece
7. Duration	V131/V145: approx. 6 months V147/V157/V158: approx. 10 months
8. IC (Integrated Circuit)	Oscillator, frequency divider and driving circuit C-MOSIC, 1 piece

* The specifications are subject to change without prior notice due to product improvements.